



CUINSOL
soler ruíz s.l.

11 - Accesorios Montaje Cocina

Zocalo PVC	Pag
Patas Axilo	124
Patas Muebles	125
Patas Mesas	126
Patas Decorativas	127
Proteccion Fregadero	128
Accesorios Horno - Encimera	129
Rejillas Horno	130
Varios Cocina	131
	132



Zocalo PVC

Código	Descripción	Acabado	Base	Largo	U.M.
01110001	H:100mm	Plata Mate	Aluminio	4m	ml
01110002	H:150mm	Plata Mate	Aluminio	4m	ml
01110003	H:170mm	Plata Mate	Aluminio	4m	ml
01110301	H:100mm	Blanco Brillo	Aluminio	4m	ml
01110302	H:150mm	Blanco Brillo	Aluminio	4m	ml
01110303	H:170mm	Blanco Brillo	Aluminio	4m	ml
01110311	H:100mm	Blanco Mate	Papel	4m	ml
01110312	H:150mm	Blanco Mate	Papel	4m	ml
01110313	H:170mm	Blanco Mate	Papel	4m	ml
01110321	H:100mm	Negro Mate	Papel	4m	ml
01110322	H:150mm	Negro Mate	Papel	4m	ml
01110323	H:170mm	Negro Mate	Papel	4m	ml

¡ Zocalo cocina PVC Nacional, con junquillo goma.

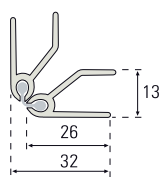

Angulo Flexible PVC

Código	Descripción	Acabado	Base	U.M.
01110210	H:100mm	Plata Mate	Aluminio	ud
01110010	H:150mm	Plata Mate	Aluminio	ud
01110110	H:170mm	Plata Mate	Aluminio	ud
01110305	H:100mm	Blanco Brillo	Aluminio	ud
01110306	H:150mm	Blanco Brillo	Aluminio	ud
01110307	H:170mm	Blanco Brillo	Aluminio	ud
01110315	H:100mm	Blanco Mate	Papel	ud
01110316	H:150mm	Blanco Mate	Papel	ud
01110317	H:170mm	Blanco Mate	Papel	ud
01110325	H:100mm	Negro Mate	Papel	ud
01110326	H:150mm	Negro Mate	Papel	ud
01110327	H:170mm	Negro Mate	Papel	ud

¡ Angulo flexible con junta de goma.

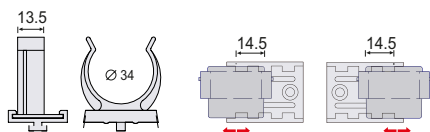

Pinza Zocalo PVC

Código	Descripción	Acabado	U.M.
01110500		Negro	ud

¡ Pinza de grapa pequeña, desplazable 14,5mm. Para zocalo de PVC



ERGONÓMICO

Ya no es necesario agacharse, arrastrarse ni estirarse: Con AXILO™ usted alcanza también cómodamente las patas de zócalo traseras.



EFICIENTE

Con AXILO™ usted siempre trabaja por delante del cuerpo, constantemente tendrá el nivel de agua a la vista – ahorrando tiempo y esfuerzo.

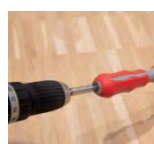

RÁPIDO

El manejo cómodo con una herramienta eléctrica también es posible – gracias a un acople para puntas de 1/4" tanto en la herramienta de regulación AXILO™ como también en el prolongador AXILO™.

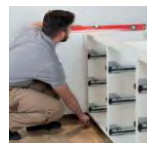

SENCILLO

La herramienta de regulación AXILO™ se puede manejar desde cualquier ángulo. Práctico sobre todo en zonas de difícil acceso.

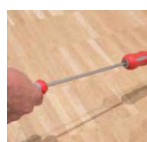

GRAN ALCANCE

La herramienta de regulación única AXILO™ sirve como brazo prolongador – con el prolongador adicional usted alcanza incluso patas de zócalo de armarios inferiores de esquina.



UNIVERSAL

AXILO™ se puede aplicar para todos los tipos de armario, tales como armario inferior de cocina, armarios de oficina hasta armarios roperos.

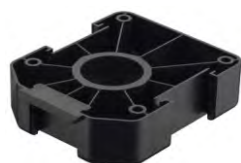

Base Atornillar

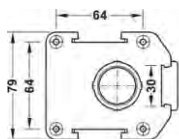

Pinza Zocalo Madera

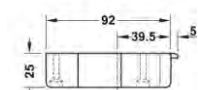

Pinza Zocalo PVC

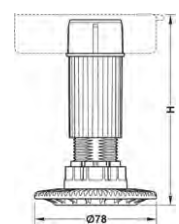

Base parquet H:2mm

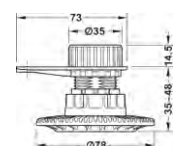

Pata



Pata H35

Pata Axilo

Código	Descripción	Altura	Acabado	U.M.
11230001	Base Atornillar	-	Negro	ud
11230010	Pata H35 (sin base)	35-48	Negro	ud
11230011	Pata H60	53-80	Negro	ud
11230012	Pata H80	70-100	Negro	ud
11230013	Pata H100	90-120	Negro	ud
11230014	Pata H120	115-145	Negro	ud
11230015	Pata H150	140-170	Negro	ud
11230016	Pata H180	170-200	Negro	ud
11230017	Pata H200	190-220	Negro	ud

¡ Necesaria base atornillar. Excepto la H35 que es de embutir D:35mm

Complementos Axilo

Código	Descripción	Acabado	U.M.
11230020	Pinza Zocalo Madera	Blanco	ud
11230021	Pinza Zocalo PVC	Negro	ud
11230025	Base Parquet (antirralladuras)	Gris	ud

¡ Pinza de grapa pequeña, desplazable 14,5mm. Para zocalo de PVC

Destornilladores Axilo

Código	Descripción	Largo	U.M.
11230030	Destornillador Maquina	660mm	ud
11230031	Destornillador Manual	640mm	ud
11230032	Prolongador Maquina	323mm	ud

¡ Necesario para poder regular las patas desde fuera del modulo



Destornillador Maquina

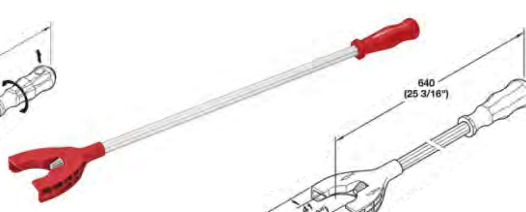

Destornillador Manual



Prolongador 323mm

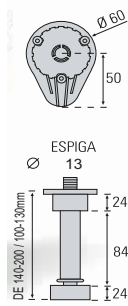

Pata Oculta Universal Teton

Código	Descripción	Acabado	U.M.
11530353	H:75-100mm	Negro	ud
11530352	H:100-130mm	Negro	ud
11530351	H:140-200mm	Negro	ud
11530365	Pinza Madera	Negro	ud

¡ Pata con espiga 13mm, universal para todos los modulos. Carga: 350kg

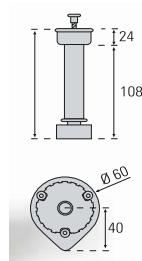

Pata Desmontable Tapon Blanco

Código	Descripción	Acabado	U.M.
11530363	H:100-130mm	Negro	ud
11530360	H:140-200mm	Negro	ud
11530365	Pinza Madera	Negro	ud

¡ Pata con tapon, universal para todos los modulos. Carga: 350kg

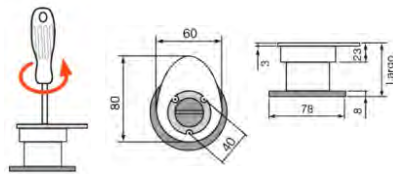

Pata Hulk Armario 50-80

Código	Descripción	Acabado	U.M.
11300001	Pata Armario 50-80	Negro	ud
11320500	Pinza Hulk 50-80	Negro	ud

¡ Pata especial para armarios, regulacion por el interior del mueble.

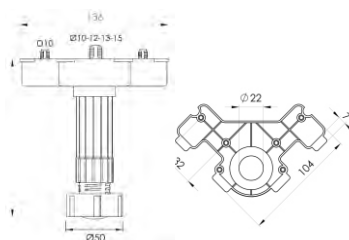

Pata Hulk Universal Teton

Código	Descripción	Acabado	U.M.
11300004	H:130-190mm	Negro	ud
11300003	H:100-130mm	Negro	ud
11300002	H:80-100mm	Negro	ud
11530365	Pinza Madera	Negro	ud

¡ Pata oculta con teton 13mm, soporte de gran superficie. Carga: 400kg

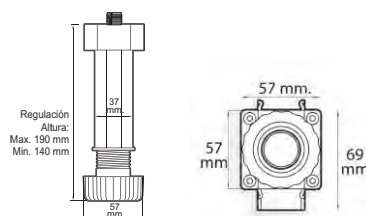

Pata Octogonal Universal Teton

Código	Descripción	Acabado	U.M.
11410001	Pata H:140-190mm	Negro	ud
11410003	Pata H:100-140mm	Negro	ud
11410006	Pinza PVC	Negro	ud
11410007	Pinza Madera	Negro	ud
11410008	Pinza Aluminio	Negro	ud

¡ Pata oculta octogonal teton 13, soporte de gran superficie. Carga: 300kg

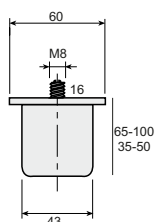

Pata Sandy

Código	Descripción	Acabado	U.M.
11320200	H:35-50mm	Negro	ud
11320201	H:65-100mm	Negro	ud

¡ Pata regulable, para pequeños espacios

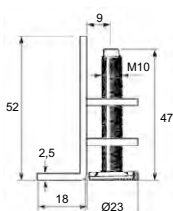

Pata Niveladora Armario

Código	Descripción	Acabado	U.M.
67400831	Pata Niveladora	Zinc	ud

¡ Pata reguladora por la parte superior. Regula +/-12mm

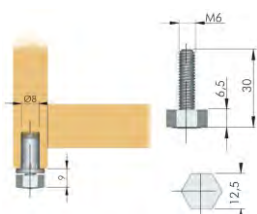

Nivelador Costado M6 8x30mm

Código	Descripción	Medidas	U.M.
12000002	Blanco	8x30	ud
12000003	Negro	8x30	ud

¡ Mínimo tablero de 16mm. Acero + base en ABS. Reg: 0 - 18mm.



Pata Aluminio Con Regulacion

Código	Descripción	Acabado	U.M.
11610054	Redonda D:40mm H:160mm	Plata Mate	ud
11610070	Cuadrada 40x40mm H:80mm	Plata Mate	ud
11610072	Cuadrada 40x40mm H:120mm	Plata Mate	ud
11610074	Cuadrada 40x40mm H:160mm	Plata Mate	ud
11610081	Cuadrada 40x40mm H:100mm	Negro Mate	ud
11610082	Cuadrada 40x40mm H:120mm	Negro Mate	ud

¡ Pata aluminio regulable 40mm. Bajo pedido, cualquier medida.

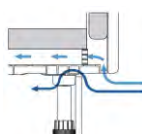

Base Ventilacion Refrigerifico Integrable

Código	Descripción	Acabado	U.M.
12920001	Base M.600 T/16mm	Negro	ud
12920002	Base M.600 T/19mm	Negro	ud
12920005	J.4 Patas 140/160mm (Recortable)	Negro	ud

¡ Aporta una superficie de aireación de 200 cm². Garantiza el flujo de aire óptimo del aparato, optimizando su consumo energético.



Junquillo Zocalo Antihumedad

Código	Descripción	Largo	Acabado	U.M.
12425013	Tablero 16mm	3600mm	Transp	ml
12425015	Tablero 19mm	3600mm	Transp	ml

¡ Protege el zocalo de la humedad. Consultar otros colores

Estructura Pata Modular

Código	Descripción	Medidas	U.M.
62125081	Ancho 40mm	Bajo pedido	ud
62125082	Ancho 50mm	Bajo pedido	ud
62125083	Ancho 60mm	Bajo pedido	ud

¡ Estructura de pata modular de aluminio. Bajo pedido cualquier medida. Uniones con refuerzo interior, gran estabilidad.

Colores disponibles:

Plata Mate - Cromo Brillo - Inox - Blanco brillo/mate - Negro brillo/mate

■ AL Aluminio ■ CB Cromo Brillo ■ IX Inox □ BL Blanco ■ NE Negro

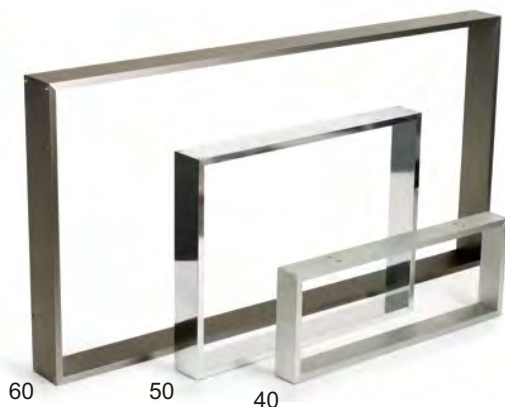

Pata Mesa Hierro Negro Mate

Código	Descripción	Medidas	Color	U.M.
62125100	Pata Trapezio	710X580x100	Negro Mate	ud
62125101	Pata Recta 40	710x580x40	Negro Mate	ud
62125102	Pata Recta 100	710x800x100	Negro Mate	ud

¡ Estructura de mesa ajustable en largo de 1100 a 1800. Facil instalacion y montaje.

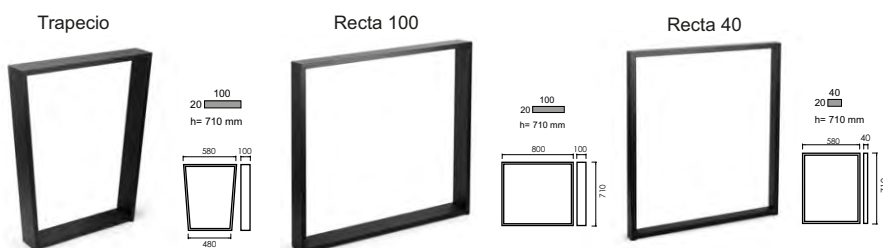

Pata Cilindrica

Código	Descripción	Diam	Acabado	U.M.
62125004	H:710mm	60mm	Cromo Mate	ud
62125005	H:710mm	60mm	Acero Inox	ud
62125008	H:830mm	60mm	Cromo Mate	ud
62125015	H:830mm	60mm	Acero Inox	ud
62100001	Extensible 710-1100	99mm	Cromo Brillo	ud

¡ Pata de mesa. Regulables en altura 30mm



Pata Extensible 710-1100

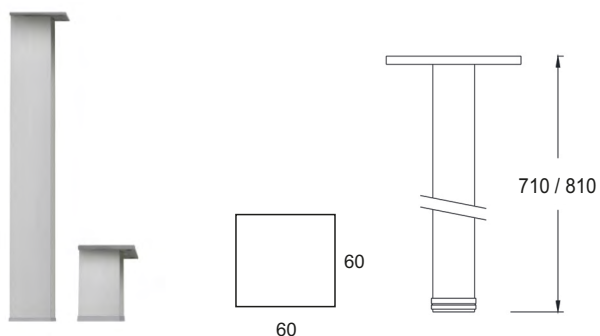

Pata Aluminio 60x60 Cuadrada

Código	Descripción	Medidas	Acabado	U.M.
62125020	H:710mm	60x60mm	P.mate	ud
62125021	H:810mm	60x60mm	P.mate	ud
62125022	H:1000mm	60x60mm	P.mate	ud

¡ Pata de mesa de aluminio anodizado. Regulable en altura: 30mm. Sobre pedido, cualquier medida en altura.

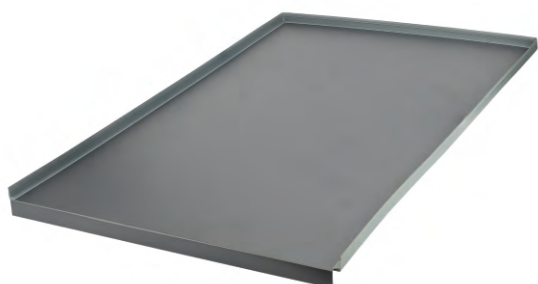

Proteccion Fregadero Plastico Antracita

Código	Descripción	Acabado	U.M.
12325003	400x580x19mm	Gris	ud
12325004	450x580x19mm	Gris	ud
12325005	500x580x19mm	Gris	ud
12325006	600x580x19mm	Gris	ud
12325007	700x580x19mm	Gris	ud
12325008	800x580x19mm	Gris	ud
12325009	900x580x19mm	Gris	ud
12325010	1000x580x19mm	Gris	ud
12325011	1200x580x19mm	Gris	ud

¡ Para tablero de 19mm. Bajo pedido, cualquier medida.
Protección lateral de goma, tres lados interiores. Perfil aluminio frontal



Proteccion Fregadero Plastico Gris

Código	Descripción	Acabado	U.M.
12820003	400x580x16mm	Gris	ud
12820004	450x580x16mm	Gris	ud
12820005	500x580x16mm	Gris	ud
12820006	600x580x16mm	Gris	ud
12820007	700x580x16mm	Gris	ud
12820008	800x580x16mm	Gris	ud
12820009	900x580x16mm	Gris	ud
12820010	1000x580x16mm	Gris	ud
12820012	1200x580x16mm	Gris	ud

¡ Stock permanente. Bajo pedido (min:10uds), cualquier medida.
Protección lateral de goma, tres lados interiores. Perfil aluminio frontal.



Proteccion Fregadero Aluminio

Código	Descripción	Acabado	U.M.
12625003	400x580x16mm	Al.Mate	ud
12625004	450x580x16mm	Al.Mate	ud
12625005	500x580x16mm	Al.Mate	ud
12625006	600x580x16mm	Al.Mate	ud
12625007	700x580x16mm	Al.Mate	ud
12625008	800x580x16mm	Al.Mate	ud
12625009	900x580x16mm	Al.Mate	ud
12625010	1000x580x16mm	Al.Mate	ud
12625012	1200x580x16mm	Al.Mate	ud

¡ Stock permanente. Bajo pedido (min:10uds), cualquier medida.
Protección lateral de goma, tres lados interiores

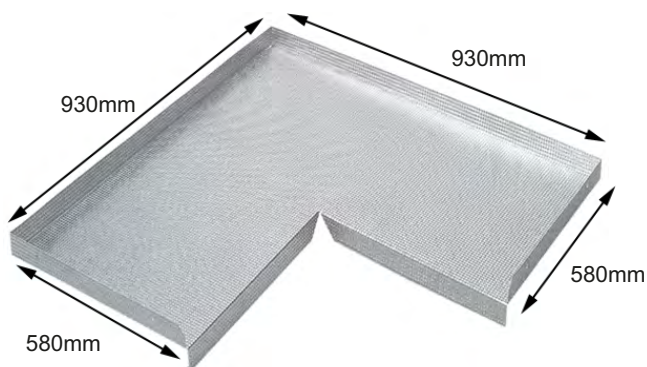

Proteccion Rincon Aluminio

Código	Descripción	Acabado	U.M.
12625085	930x930x580	Al.Mate	ud

¡ Stock permanente. Bajo pedido (min:10uds), cualquier medida.
Protección lateral de goma, tres lados interiores



Refuerzo Horno Aluminio

Código	Descripción	Medidas	Acabado	U.M.
11830001	600mm	20x20mm	P.mate	ud
11830002	700mm	20x20mm	P.mate	ud
11830003	800mm	20x20mm	P.mate	ud
11830004	900mm	20x20mm	P.mate	ud
11830005	1000mm	20x20mm	P.mate	ud
11830020	3000mm	20x20mm	P.mate	ml
11830022	Soporte barra Pvc	-	Gris	ud

¡ Refuerzo de aluminio para módulos de cocina bajos. Soporte atornillable.

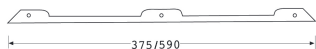

Protector Lateral Horno

Código	Descripción	Largo	Acabado	U.M.
11825001		600mm	Ac.Inox	Ju

¡ Juego de laterales de acero inoxidable, protege los costados del horno.

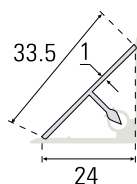

Copete Encimera Liso 45°

Código	Descripción	Largo	Acabado	U.M.
00750001	Copete 45°	4000mm	PI.Mate	ml
00750002	Esquina 45°		PI.Mate	ud
00750003	Rincon 45°		PI.Mate	ud
00750004	Tapa Dch/Izq 45°		PI.Mate	ud

¡ Copete de aluminio, para colocar sobre encimeras de postformado. Diseño reducido minimalista.



Cubrecantos Frigo Inox

Código	Descripción	Acabado	U.M.
12210001	605x16mm	Inox	ud
12210005	605x19mm	Inox	ud
12210010	605x20mm	Inox	ud
12210011	605x22mm	Inox	ud

¡ Stock permanente. Bajo pedido (min:10uds), cualquier medida y grosor. Protección ante la humedad de los costados de los muebles.

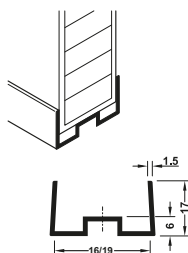
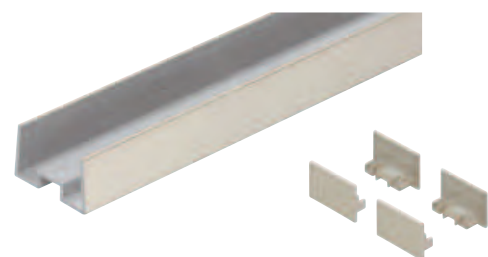

Perfil Canto PVC Inox

Código	Descripción	Acabado	U.M.
12110001	Perfil 16mm 2500mm	Inox	ud
12110002	Perfil 19mm 2500mm	Inox	ud
12110011	Tapa 16mm	Inox	ud
12110012	Tapa 19mm	Inox	ud

¡ Perfil de plástico recortable, para la terminación al suelo de costados. Tapas de plástico autoadhesivas.

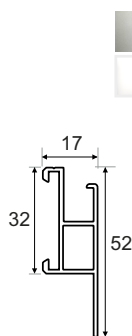

Refuerzo Ventoo

Código	Descripción	Medidas	Acabado	U.M.
11700006	Plata Mate	600mm	Aluminio	ud
11700007	Plata Mate	700mm	Aluminio	ud
11700008	Plata Mate	800mm	Aluminio	ud
11700009	Plata Mate	900mm	Aluminio	ud
11700010	Plata Mate	1000mm	Aluminio	ud
11700011	Plata Mate	1200mm	Aluminio	ud
11700106	Blanco Mate	600mm	Aluminio	ud
11700107	Blanco Mate	700mm	Aluminio	ud
11700108	Blanco Mate	800mm	Aluminio	ud
11700109	Blanco Mate	900mm	Aluminio	ud
11700110	Blanco Mate	1000mm	Aluminio	ud
11700111	Blanco Mate	1200mm	Aluminio	ud

¡ Dos funciones: Refuerzo + Ventilación de placas de induccion. Tab:16mm



Tabika Induccion

Código	Descripción	Medidas	Acabado	U.M.
62830040	Acero Inox	20x600mm	Ac.Inox	ud
62830041	Blanco Mate	20x600mm	Aluminio	ud
62830042	Negro Mate	20x600mm	Aluminio	ud
62830043	Acero Inox	20x900mm	Ac.Inox	ud
62830044	Blanco Mate	20x900mm	Aluminio	ud
62830045	Negro Mate	20x900mm	Aluminio	ud

¡ Tabika aireación de una sola pieza. Para ventilacion de placa induccion.

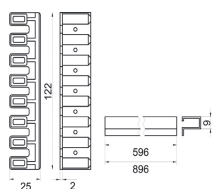

Rejilla Horno Lamas

Código	Descripción	Medidas	Acabado	U.M.
62630001	Acero Inox	122x600mm	Ac.Inox	ud
62630002	Blanco Brillo	122x600mm	Aluminio	ud
62630003	Negro Mate	122x600mm	Aluminio	ud
62630004	Plata Mate	122x600mm	Aluminio	ud
62630005	Blanco Mate	122x600mm	Aluminio	ud
62630011	Acero Inox	122x900mm	Ac.Inox	ud
62630012	Blanco Brillo	122x900mm	Aluminio	ud
62630013	Negro Mate	122x900mm	Aluminio	ud
62630014	Plata Mate	122x900mm	Aluminio	ud
62630015	Blanco Mate	122x900mm	Aluminio	ud
62630018	Sop. Rejilla Blanco	122mm	Pvc	ud
62630019	Sop. Rejilla Negro	122mm	Pvc	ud

¡ Rejillas de horno de 8 lamas metalicas. Recortables en anchura y altura.



Tabikas Horno Fija

Código	Descripción	Medidas	Acabado	U.M.
62830001	Blanca	85x600mm	Aluminio	ud
62830002	Negra	85x600mm	Aluminio	ud
62830003	Acero Inox	85x600mm	Ac.Inox	ud

¡ Tabika de aireación de una sola pieza.

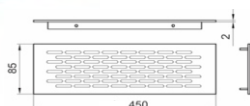

Chapa Ventilacion

Código	Descripción	Medidas	Acabado	U.M.
62830101	Plata Mate	70x450mm	Aluminio	ud
62830102	Blanca Brillo	70x450mm	Aluminio	ud
62830103	Inox Brillo	70x450mm	Aluminio	ud
62830104	Negro Mate	70x450mm	Aluminio	ud
62830105	Blanco Mate	70x450mm	Aluminio	ud
62830106	Antracita Mate	70x450mm	Aluminio	ud

¡ Chapas de ventilacion en aluminio para encastrar.



601 / 801



605 / 805



610 / 810



615 / 815



630 / 830



670 / 870



635 / 835



660 / 860 / 228



625 / 826



620 / 820



550 / 852



652 / 850

tubo Extracción D:100mm / 60x120mm

Código	Descripción	U.M.
66150001	601-Tubo Rectangular D:100 / 1500mm	ud
66150002	605-Tubo Redondo 60x120 / 1500mm	ud
66150003	610-Empalme Rectangular	ud
66150004	615-Empalme Redondo	ud
66150005	620-Empalme Mixto	ud
66150006	625-Codo Mixto	ud
66150007	630-Codo Vertical	ud
66150008	635-Codo Horizontal	ud
66150011	652-Ventanilla Rectang.	ud
66150012	550-Ventanilla Redonda	ud
66150016	670-Codo Redondo	ud
66150015	660-Reductor 120-100mm	ud
66115017	228-Reductor 150-100mm	ud

tubo Extracción D:120mm / 75x150mm

Código	Descripción	U.M.
66400030	801-Tubo Rectangular D:120 / 1500mm	ud
66400031	805-Tubo Redondo 75x150 / 1500mm	ud
66400032	810-Empalme Rectangular	ud
66400033	815-Empalme Redondo	ud
66400034	820-Empalme Mixto	ud
66400035	826-Codo Mixto	ud
66400036	830-Codo Vertical	ud
66400038	835-Codo Horizontal	ud
66400039	870-Codo Redondo	ud
66400040	850-Ventanilla Rectangular	ud
66400041	852-Ventanilla Redonda	ud
66400042	860-Aro reductor 125-120mm	ud



tubo Flexible Aluminio

Código	Descripción	Largo	Acabado	U.M.
66030001	D:100mm	5000mm	Aluminio	ml
66030002	D:110mm	5000mm	Aluminio	ml
66030003	D:120mm	5000mm	Aluminio	ml
66030004	D:150mm	5000mm	Aluminio	ml

Cerco Microondas Universal

Código	Descripción	Medidas	Acabado	U.M.
12725001	Blanco Brillo	450x600mm	Plastico	ud
12725002	Negro Brillo	450x600mm	Plastico	ud
12725003	Niquel Mate	450x600mm	Plastico	ud

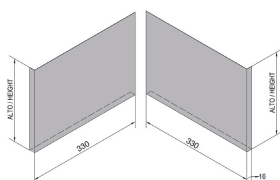
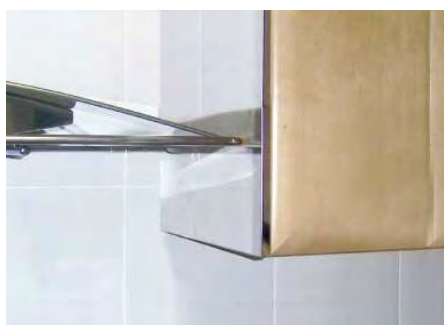
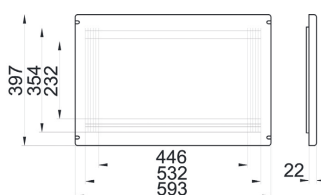
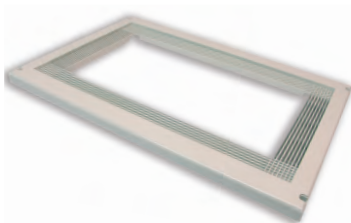

Protectores Laterales de Campana

Código	Descripción	Medidas	Acabado	U.M.
12510040	Blanco	230x300mm	Aluminio	Ju
12510042	Acero Inox	230x300mm	Ac.Inox	Ju
12510050	Blanco	230x330mm	Aluminio	Ju
12510052	Acero Inox	230x330mm	Ac.Inox	Ju
12510025	Blanco	700x300mm	Aluminio	Ju
12510027	Acero Inox	700x300mm	Ac.Inox	Ju
12510005	Blanco	700x330mm	Aluminio	Ju
12510007	Acero Inox	700x330mm	Ac.Inox	Ju
12510028	Blanco	900x300mm	Aluminio	Ju
12510030	Acero Inox	900x300mm	Ac.Inox	Ju
12510001	Blanco	900x330mm	Aluminio	Ju
12510003	Acero Inox	900x330mm	Ac.Inox	Ju

 Con dos pestañas para tablero de 16mm. Bajo pedido, cualquier medida.